



Physics on Stage 2
2002

**Demonstrations
&
Teaching Ideas**

**Selected by the
Irish Team**

The National Steering Committee for Physics on Stage 2 has made every effort to ensure the good quality of the information presented in this publication. Teachers should ensure the safety of the demonstrations in their own laboratories. This is a voluntarily produced document that is intended as a support resource for teachers of physics and is not published for profit.

Physics on Stage 2 gives permission to educational organisations to reproduce material from this book without prior notification provided it is for the purposes of education, is not for profit and suitable acknowledgement to Physics on Stage 2 is given. Physics on Stage 2 would be grateful to receive a copy of any other publication using material reproduced from this book.

As numerous people contributed to this book, it was necessary to accommodate a variety of presentation styles. Any corrections or suggestions would be welcomed by the committee and can be sent to:

Alison Hackett, Physics on Stage 2, c/o School of Science and Technology,
Dun Laoghaire Institute of Art Design and Technology, Dun Laoghaire, Co Dublin.

Contributors

Paul Nugent

Michael Grehan

Angela Kelly

Alison Hackett

Patrick Lyne

Brendan O'Donoghue

Elaine Collins

Ian Elliott

ACKNOWLEDGEMENTS	iv
INTRODUCTION	vi
1 PRESSURE	1
2 FORCES	10
3 DENSITY	22
4 HEAT	30
5 WAVES & SOUND	33
6 LIGHT	37
7 ELECTRICITY & MAGNETISM	46
8 MISCELLANEOUS	49

This project was made possible by the generous sponsorship of Forfás, Physics on Stage and the Institute of Physics in Ireland.

As the only member of the team involved in Physics on Stage 2 who was not working in a voluntary capacity it seems appropriate that I use this space to formally thank those involved. It was a privilege to have worked with a team who are all in full time demanding positions yet so selflessly gave their free time to the Physics on Stage 2 project.

Firstly, sincere thanks to Paul Nugent and Michael Grehan who as well as being involved at almost every other stage of POS2, produced at least 90% of this document. This included testing, developing and writing up a great number of the demonstrations and working on it right through to the final stages of production. This publication would not have happened without their very professional commitment.

The gratitude of all the team must go to Brendan O'Donoghue as secretary of POS2. Brendan was greatly involved in the initial stages, which included arranging the mailing of a request for demonstration submissions for POS2 from physics teachers in every school. He carried out all the complex and lengthy communications with POS2 and the organisation of the delegates' trip to Holland.

Angela Kelly was the only delegate who was also at the first Physics on Stage and our thanks to her for once again taking part in POS2 and also for great help in producing the first document that went to POS2 with the delegates.

From the demonstration submissions the committee selected Patrick Lyne and Elaine Collins as POS2 delegates. Thanks for their time, effort and full participation in the event and also to Patrick for the section on web sites in this publication.

The treasurer Eamonn Cunningham provided invaluable support with management of the finances and a reassuring experience with the detail having also acted as treasurer for POS1. Our thanks to Eamonn.

As the first Physics on Stage 2 contact, Ian Elliott spent considerable time finding a committee who would act for POS2. Thanks are due to Ian for providing the initial 'bridge' as secretary from POS1 and for his help and always sound advice.

Andy Shearer was in the difficult position of being based at NUI Galway but taking part in an essentially Dublin based project. Thanks to Andy for his help and also to his colleague Symeon Charalabides for setting up the web site.

The National Steering Committee for Physics on Stage 2 would also like to thank the following institutions and people for contributing their time and resources to help us with this project:

Leo Enright; Tim Regan and Pdraig O Léime (the Physical Sciences Initiative).
Dun Laoghaire Institute of Art Design and Technology; Dublin Institute for Advanced Studies; Dublin City University; NUI Galway; Trinity College Dublin Physics department; the management of the following schools: Sandford Park School, Ranelagh, Dublin; Coolmine Community School, Coolmine, Dublin; St Dominic's High School, Santa Sabina, Sutton, Dublin; St. Mary's Secondary School, Macroom, Co. Cork, Loreto Secondary School, Wexford; Ronan Jacob, Belvedere College Dublin. Special thanks are due to Fr Leonard Moloney SJ for the use of the facilities at Belvedere College Dublin for committee and lab meetings.



The Irish delegation to Physics on Stage 2 (l to r) Patrick Lyne, Michael Grehan, Brendan O'Donoghue, Elaine Collins, Angela Kelly, Paul Nugent.

What's this?

A booklet of practical ideas for teachers of Physics and Junior Science.

Who's it from?

A group of Irish science teachers who took part in the second Physics on Stage conference with the help of Forfás, the National Steering Committee of Physics on Stage and the Institute of Physics in Ireland.

Where and when was that?

300 physics educators from 23 countries were guests at the European Space Agency's facility: ESTEC in Noordwijk on the coast of Holland from April 2-6, 2002.

Why the booklet?

- ❖ While you may be using many of these ideas already we hope you'll find some useful items to add to your physics demonstrations and your students' experimental work.
- ❖ We hope that more teachers may like to get involved in the range of science education events sponsored by some of Europe's large research facilities.
- ❖ To invite teachers to contact us with more ideas or requests for information and so encourage more networking between science teachers in Ireland.

How can more teachers get involved?

By contacting us or by going to the websites of the European research organisations where you will find contact addresses for more information.

The Physics on Stage website is www.physicsonstage.net and it has links to the other organisations. The Irish site is at <http://www.pos.ie>

We may be contacted by sending an e-mail to alison.hackett@iop.org

Which organisations are behind all this?

Physics on Stage was initially launched by the three agencies noted below with support from the European Union and the other participating organisations.

ESA	The European Space Agency	http://www.estec.esa.nl
ESO	The European Southern Observatory	http://www.eso.org
CERN	The European Centre for Particle Physics	http://welcome.cern.ch

Other participating organisations were:

EPS	The European Physical Society,
EAAE	The European Association for Astronomy Education,
EMBL	The European Molecular Biology Laboratory and
ESRF	The European Synchrotron Radiation Facility.

Demonstration of atmospheric pressure

Cut the base off a plastic water bottle but keep the lid screwed tightly on.

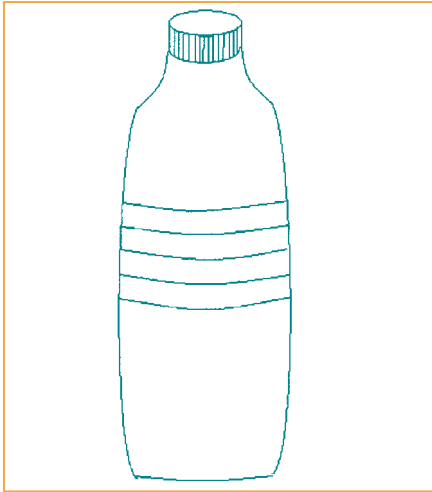

Cut out a small hole (that can be closed off using your forefinger) near the lid.

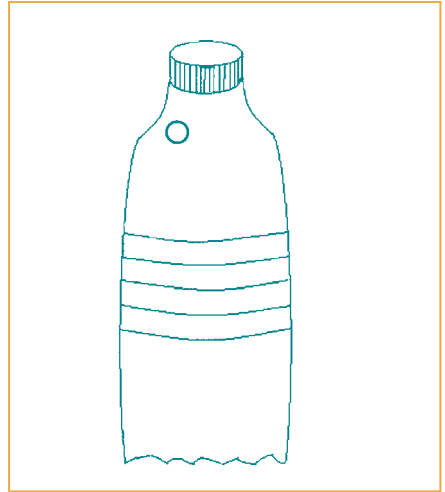

Place the bottle in a larger non-transparent container filled with water.



Lift the bottle slowly out of the water with the hole at the top uncovered.

The bottle appears empty.

Lift the bottle slowly out of the water with your finger covering the small hole at the top and the bottle appears full.

Atmospheric pressure

Procedure

- (1) Place some water in a conical flask.
- (2) Heat the water until it boils.
- (3) Place a hard-boiled egg (*one that has the outer shell removed*) on top of the flask.
- (4) Ensure that the egg stops the steam from escaping by placing it firmly on the flask.
- (5) Wait and observe.

Result

The egg will fall into the flask illustrating atmospheric pressure.

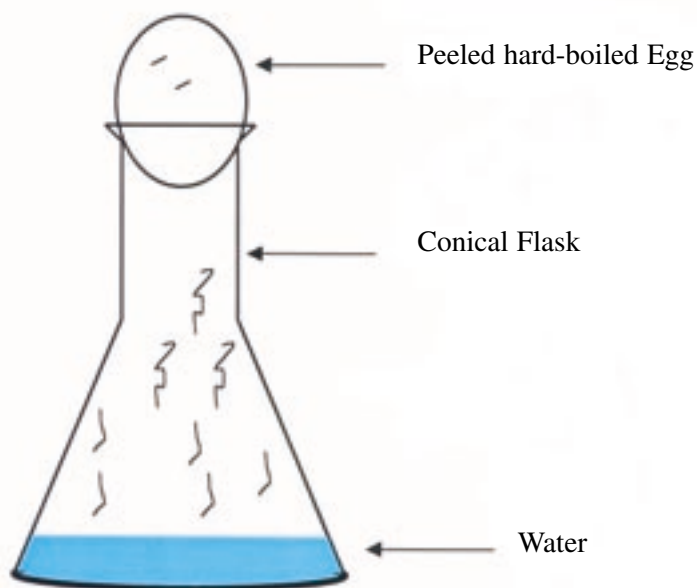

Bernoulli effect 1: ping-pong ball in funnel

ITALY: Marisa Sasso and team

Place the Ping-Pong ball into the funnel.

Blow down.

The ball rises due to the reduced pressure.

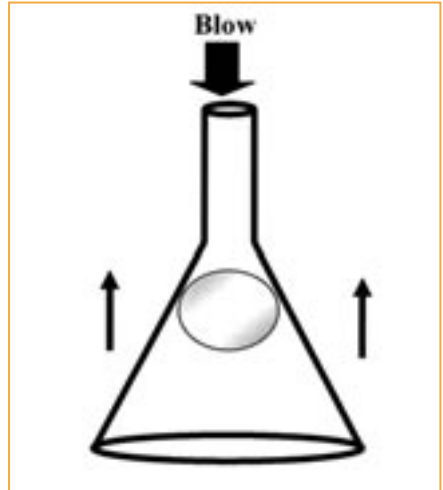

Bernoulli effect 2: ping-pong ball in eggcup

ITALY: Marisa Sasso and team

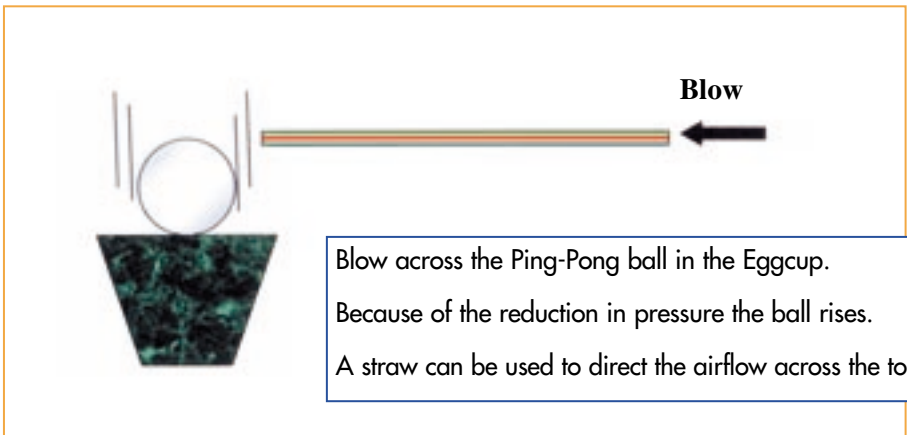

Blow across the Ping-Pong ball in the Eggcup.

Because of the reduction in pressure the ball rises.

A straw can be used to direct the airflow across the top.

Communicating balloons

NETHERLANDS: 'Discovery Game' Piet Blankert and Johan van de Adel

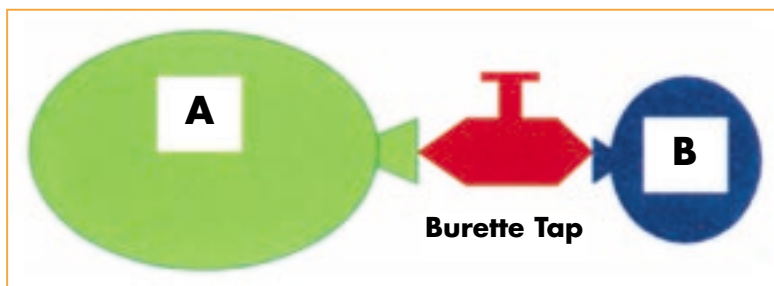

Balloon A is well inflated, Balloon B is partially inflated

What happens when the tap is opened?

- (1) A gets smaller B gets bigger
- (2) A gets bigger B gets smaller
- (3) They become the same size
- (4) There is no change

Answer: The hardest part of blowing up a balloon is near the beginning, this is because there is a strong resistance caused by the elasticity of the rubber.

Different results can be achieved depending on how much air is in B.

These results can be counter-intuitive and will hopefully promote thought and discussion amongst students.

Further topics: Elasticity, Materials Pressure, Atmospheric Pressure, etc.

The Bernoulli effect 3: the slipstream

IRELAND

Blow Hard



Place a card/sheet of glass/
or best clear Perspex about
5cm wide in front of the candle.

Blow hard – the candle flame
flickers towards the obstacle.



Blow Hard

Place a glass bottle
in front of the candle.

This time the candle flickers away.



The Bernoulli effect 4: the pipe

IRELAND:

Use: 1 thread spool
3 Pins
1 straw
1 Ping-Pong Ball
(or spherical polystyrene)
Some Blu-tak

Assemble as shown

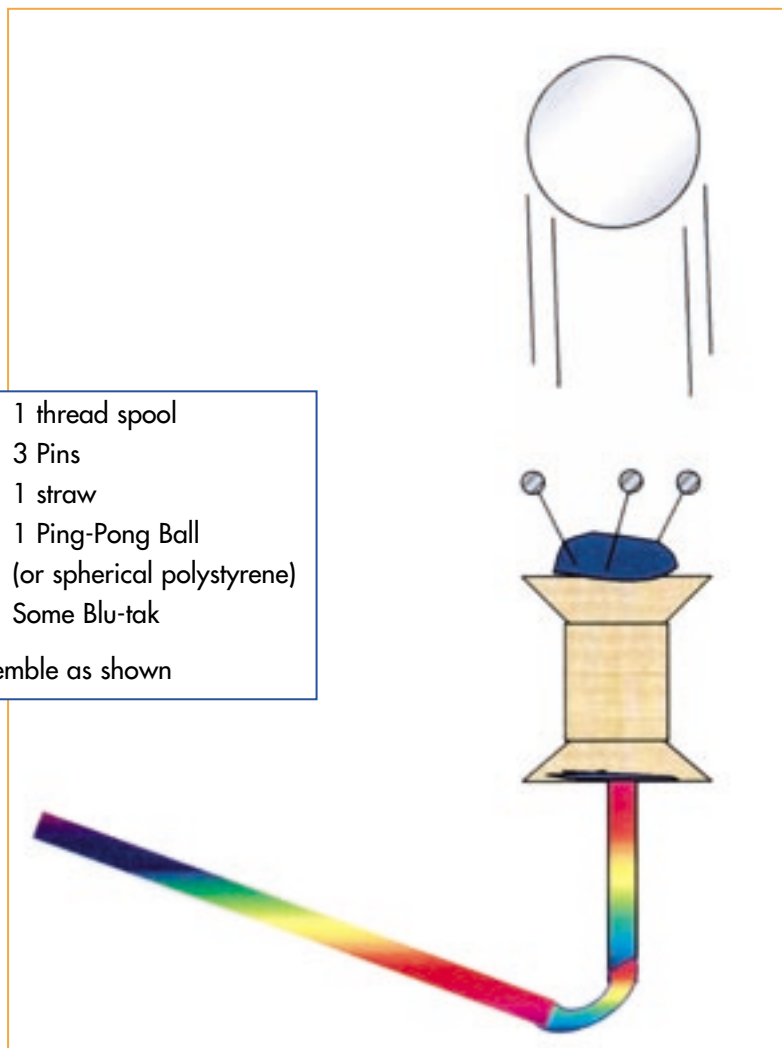

A simpler version can be made using just a polystyrene ball and a straw with a bend.

Further Topics: Aerofoils, Spoilers, Shower Curtains, Atomisers, etc.

The atmospheric karate chop

IRELAND:

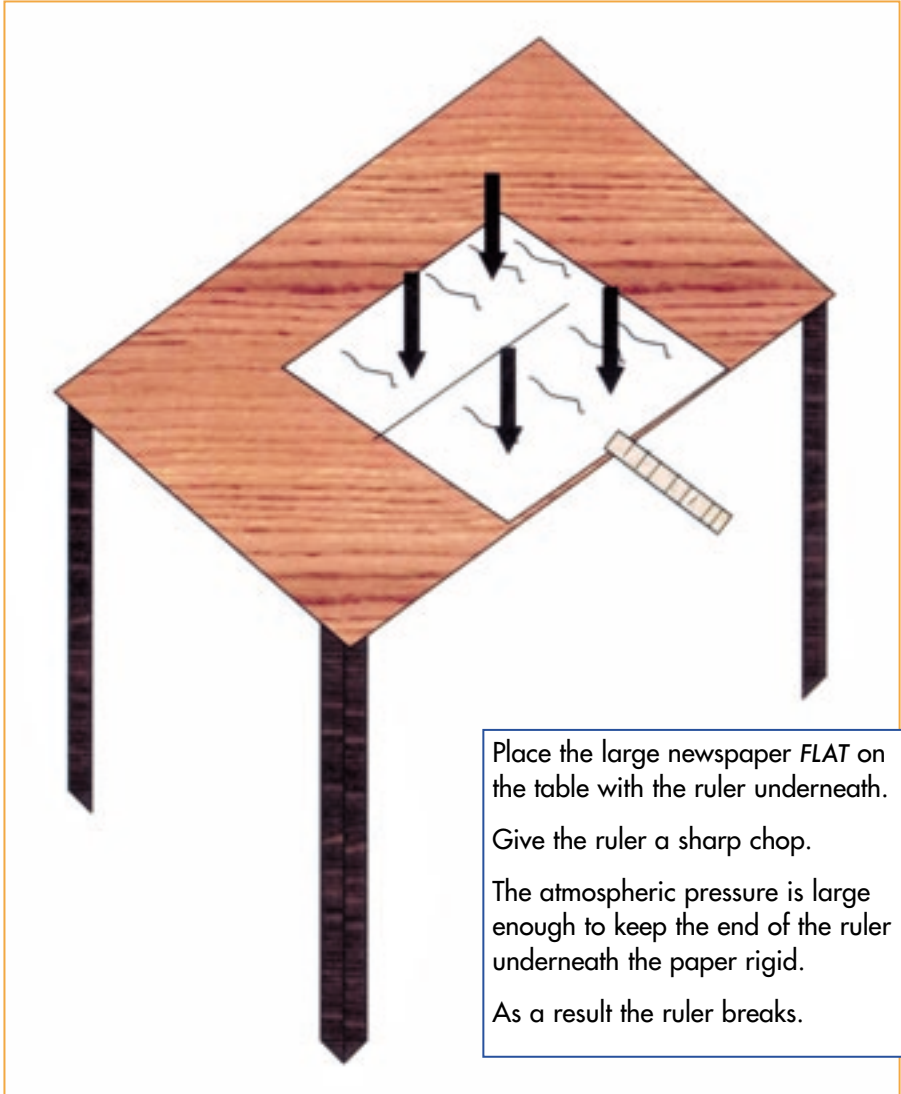

Place the large newspaper *FLAT* on the table with the ruler underneath.

Give the ruler a sharp chop.

The atmospheric pressure is large enough to keep the end of the ruler underneath the paper rigid.

As a result the ruler breaks.

Pressure

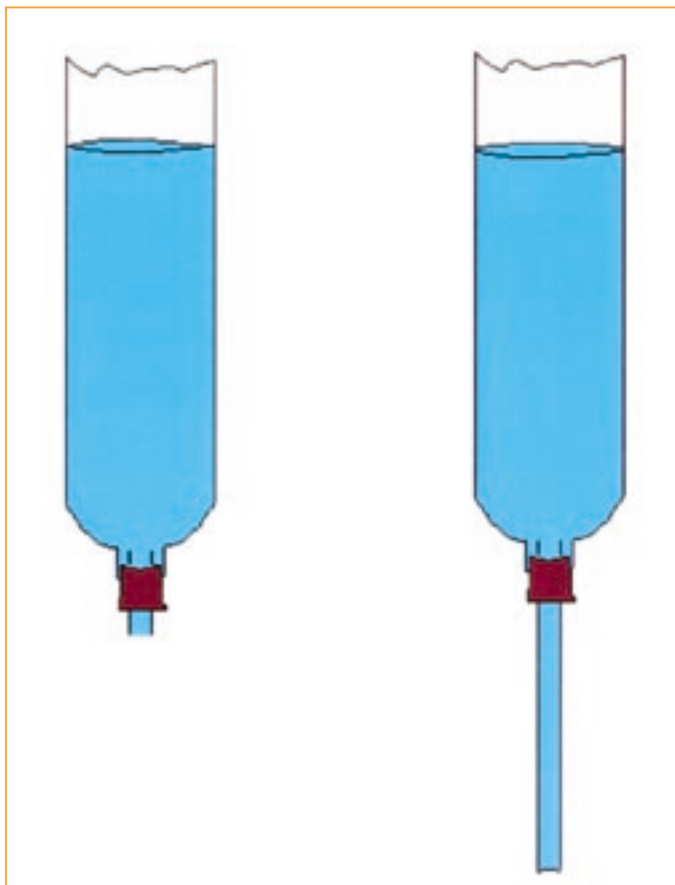

Will one bottle empty faster than the other if the same volume of liquid is in both?

Use plastic soda bottles with the base cut off for this demonstration.

The rate at which water flows out of the bottle is proportional to the pressure at the bottom of the exit tube.

The pressure at the bottom of a column of water is proportional to the height of the column of water above it.

'Heron's Fountain' [Heron is also known as Hero of Alexandria]

SWEDEN: Per Olaf Nilsson demonstrated a more elaborate version

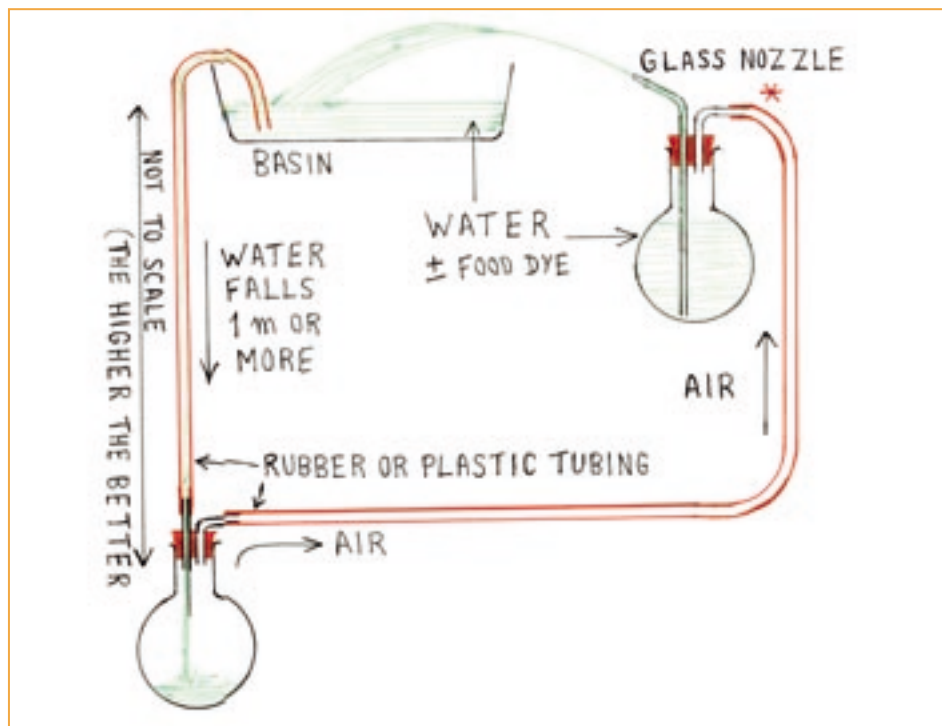

A small fountain sprays water into a basin. The fountain is supplied by a flask of water **below** it. Water from the basin drains into second flask which is lower down. Ask students how the water has enough energy to spray out of the fountain at the top. We made this simple version using only standard laboratory items. It was also very easy to start by sucking air through the plastic tube at * then it ran for about 10 minutes before the flasks needed to be exchanged. Try increasing the height of the head of falling water. We used:

2 flasks (1 litre or 500 ml, conical or flat bottomed, what the heck?)

2 two-holed rubber bungs to fit the flasks.

2 metre, or so, of plastic or rubber tubing to fit the glass tubing.

1.5 m of 6mm glass tubing, cut into 4 pieces and worked as shown.

Newton's third law

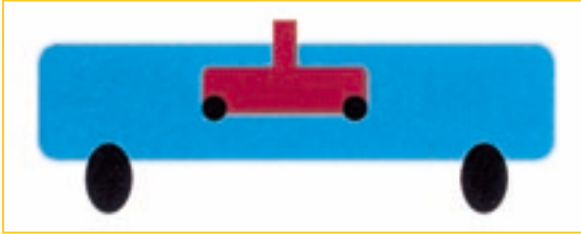

1. Place a wind-up toy clockwork train on a track with wheels.
2. Set the train to move forward and see the track moving backwards.

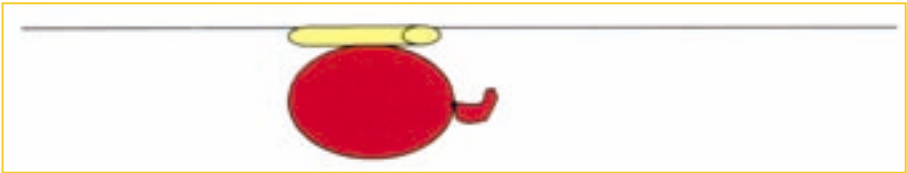

1. Attach a balloon to a straw and pass a piece of wire through the straw so that it is free to move along the wire.
2. Release the air from the balloon and notice that the balloon moves in the opposite direction to the direction of the air being released.

Newton's third law

For every action there is an equal and opposite reaction

1.



Place a teaspoon full of baking soda and 10mls of vinegar inside the plastic bottle. Quickly replace the rubber stopper. After a few seconds the build up of pressure from the carbon dioxide causes the stopper to fly off in one direction while the bottle shoots back in the opposite direction. By placing the bottle on rollers such as pencils the effect is enhanced.

2.

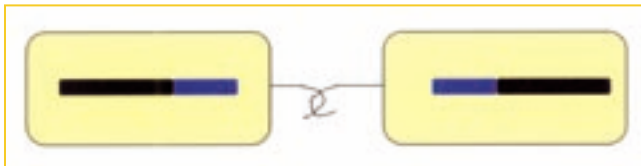

By using two spring balances Newton's third law may also be simply demonstrated. Pulling on the spring balances should lead to the same reading on each one.

Eggsperiment 1: spinners

NETHERLANDS: 'Discovery Game' Piet Blankert and Johan van de Adel

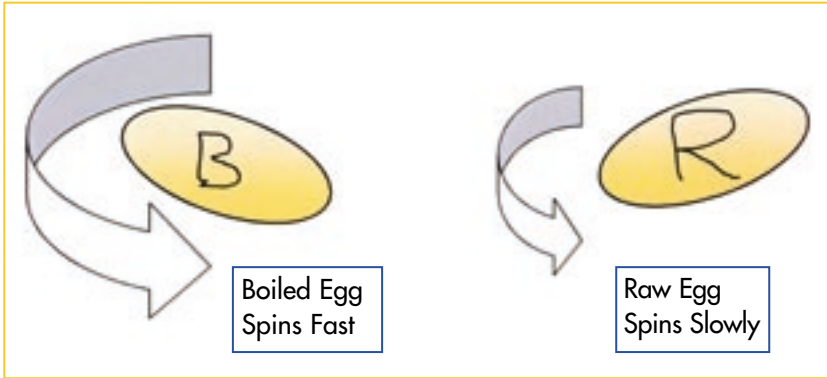

Spin two eggs one boiled, one raw.

The liquid in the raw egg also needs to rotate, so the egg spins irregularly and more slowly than the cooked egg.

Eggsperiment 2: the great egg race

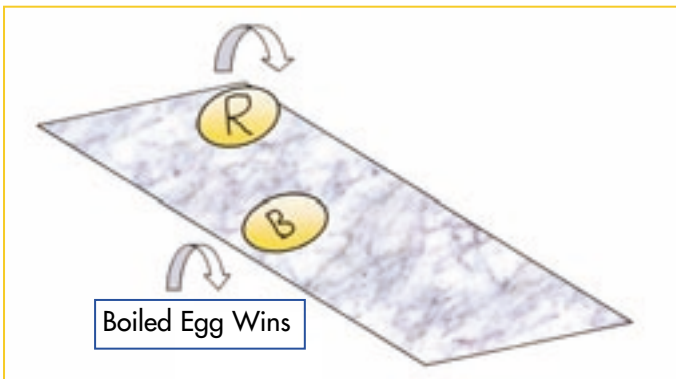

Further Topics: Linear Motion, Rotational Motion, Inertia, etc.

To show air has mass

SPAIN: 'Teaching Physics with a Smile' by Rafael Garcia Molina

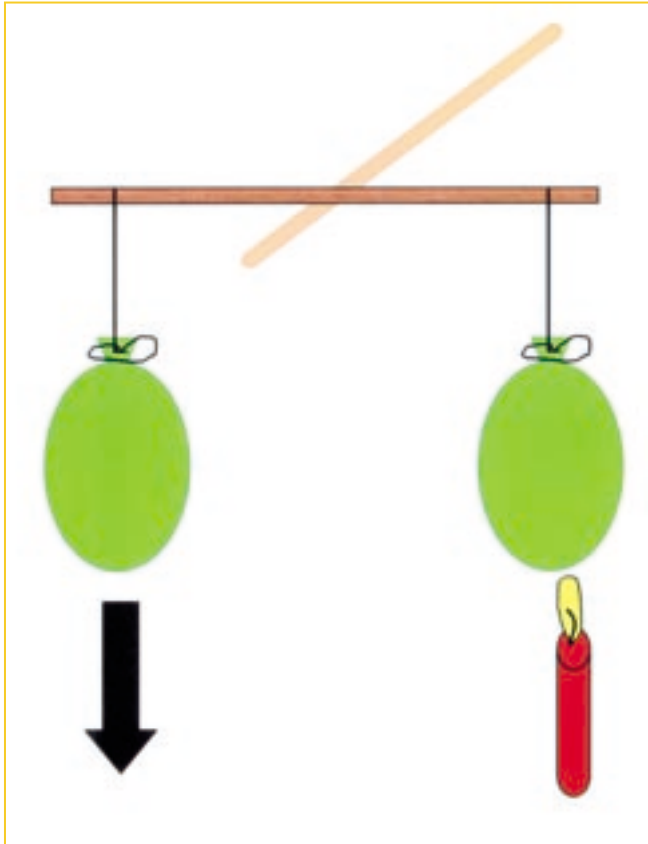

Balance a metre stick as shown.

Burst the balloon.

The balloon on the left swings down as this side is now heavier.

Roll uphill can

SPAIN: 'Teaching Physics with a Smile' by Rafael Garcia Molina

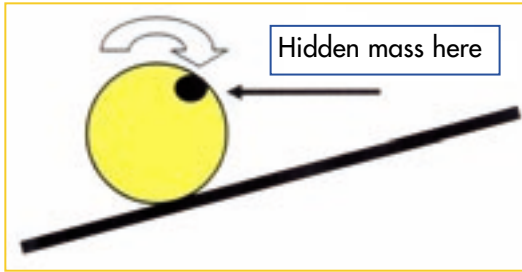

Place a weight inside the biscuit tin (a magnet is ideal).

The tin will roll up the slope (at least half a turn!), appearing to defy gravity.

Alternatively, the tin can be made to roll away on it's own if placed on a level surface.

Further Topics: Centre of Gravity, Equilibrium, Rotational Energy, etc.

Roll back can 'the perfect pet'

ITALY: Marisa Sasso and team.

Punch two holes in each end of the can.

Loosely fit the band and weight

When the tin is pushed away the band tightens

When the tin stops, the elastic unwinds and the can rolls back.

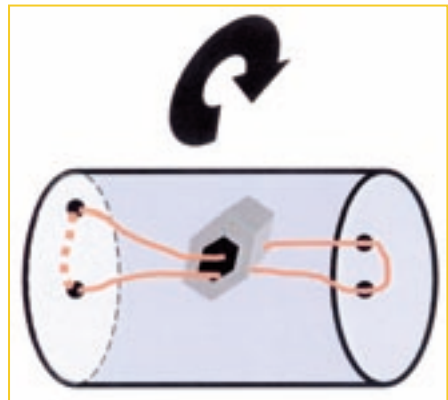

Further Topics: Potential Energy, Kinetic Energy, Motion, Engines, etc.

Surface tension – ‘water-knot’

ITALY:

Take a plastic bottle and make 5 straight holes near the bottom about 5mm apart.

Fill the bottle with water, the water comes out in 5 streams.

Pinch the jets with your thumb and forefinger the jets will form one.

Fill the bottle and put the top on.
What happens to the flow?
Why?

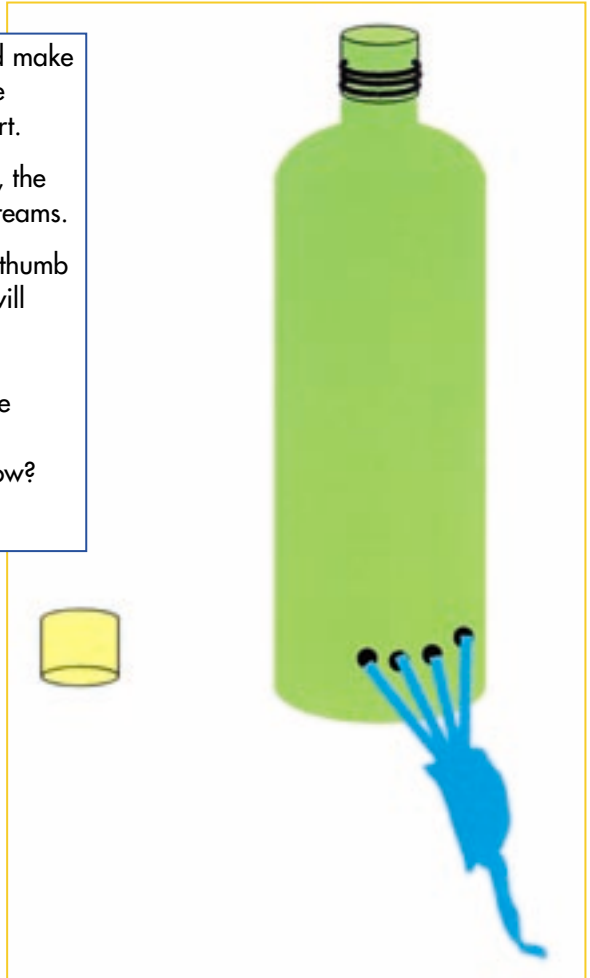

Forces

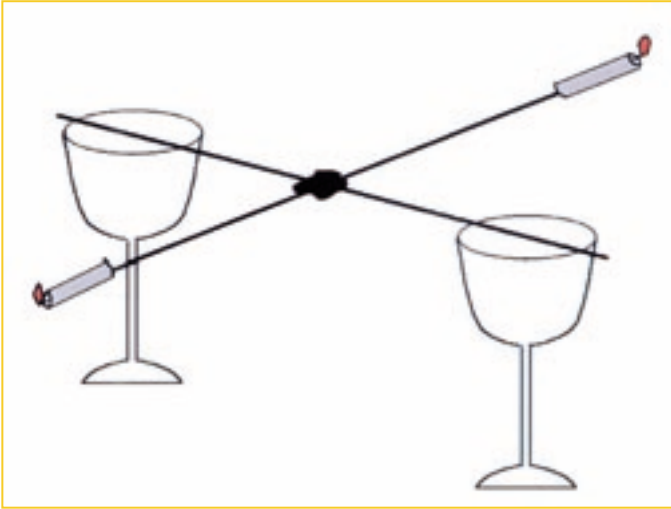

Use kebab sticks and blue tack to assemble this demonstration. Candles will oscillate when lit demonstrating balance.

Balancing cola cans



Cola can balances on it's side when filled sufficiently with liquid.

The paperclip and the falling teacup

SWEDEN: Per Olaf Nilsson

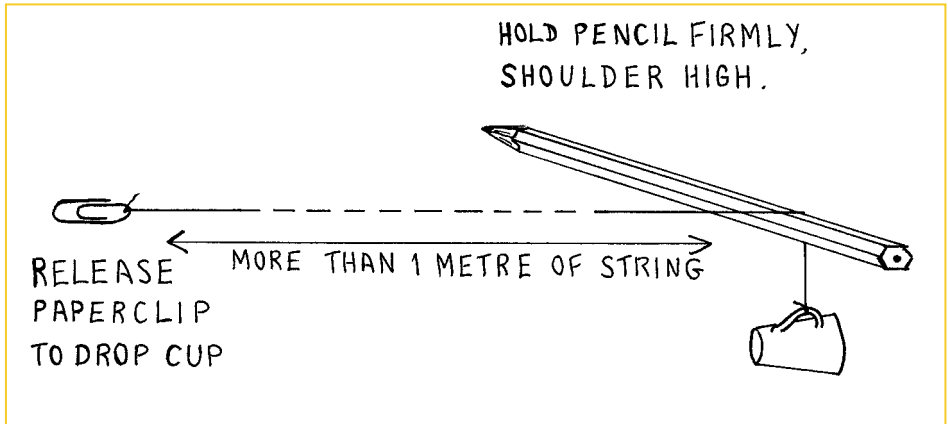

Take about 1.5 metre of string. Tie one end to the handle of a (cheap) teacup and the other to an ordinary paperclip. Hold a pencil horizontally in one hand – at shoulder height. Hold the paperclip in the other hand and draw the string across the pencil until the cup is hanging about 1.5 metres above the floor.

(A soft mat under the cup is reassuring while you practice this.) Ask your students to predict what will happen if you release the paperclip. Let go. We usually ended up with at least three turns of string around the pencil and we haven't broken the cup yet – but imagine the delight of our students if we do!

This may lead to a discussion about angular momentum. As the radius of the paperclip's rotation about the pencil decreases, what happens to its angular velocity?

A simple model of planetary motion

A handy way of looking at bigger and smaller orbits. How do the periodic times compare? How does the energy vary? What happens if we increase or decrease the centripetal force on the satellite?

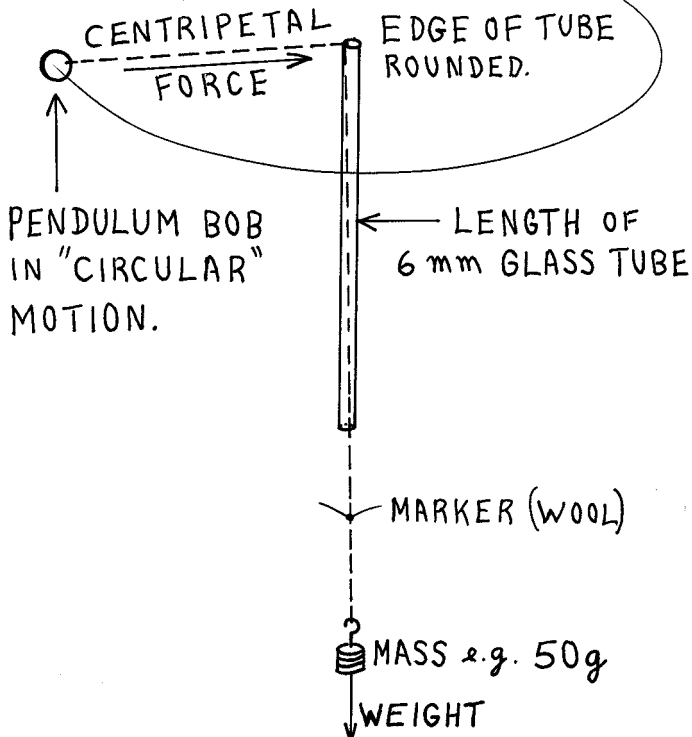

Forget Biro tubes. We get good results with about 150mm of 6mm glass tubing and the main thing is to *round the edges* of the glass at both ends by softening in a Bunsen flame. Pass about 1 metre of fine string or strong thread through the tube. Attach a pendulum bob or other small mass to one end and a weight carrier of mass about 50g to the other end. Hold the tube upright, give the bob a whirl and use a slight movement of the tube to keep it moving in a "circle" of about 500mm radius. Then hold the tube more steadily and see the satellite spiral into smaller orbits as it loses kinetic energy. At the same time the weight carrier loses potential energy. May be compared to planets or satellites and may also be related to electrons in different energy levels as atoms absorb or emit light.

The inclined plane

This apparatus can be used to show that:

1. Acceleration due to gravity is independent of mass.
2. Vertical acceleration is independent of the horizontal component of velocity.

Background

Pupils studying motion often have great difficulty in accepting that acceleration due to gravity is independent of mass, or the independence of vertical and horizontal motion.

The apparatus depicted here is a simple way to illustrate these points. Such a demonstration may be done quantitatively, with the use of photogates and data logging equipment, or qualitatively, by simple repetition and observation.

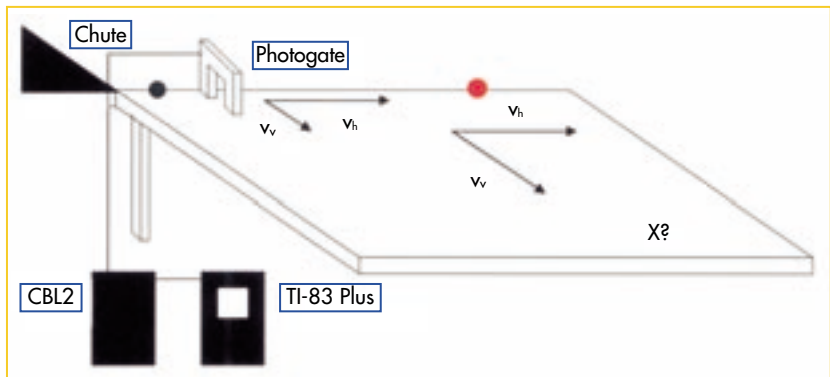

(Note: The chute must direct the ball-bearing straight across the top of the inclined plane, i.e. to ensure it possesses no vertical velocity component at the start of its motion on the plane.)

To show that acceleration due to gravity is independent of mass

Procedure 1

Two ball bearings with different masses are simultaneously released from rest at the top of the slope and allowed to roll freely down the incline. (If the slope is too long, the larger ball bearing moves ahead of the smaller due to differences in the effects of wind resistance depending on surface area and mass.)

The process is repeated several times by the pupils, using a selection of different size ball bearings. For practice, the motions of two ball bearings of the same mass can be compared with each other first, and then pupils compare the motions of those with differing masses.

The pupils quickly establish the truth of the proposition that the acceleration down the inclined plane is independent of mass.

Historical Perspective

The pupils can be required to research the work of Galileo and his use of the experimental method in overturning the Aristotelian proposition that acceleration during freefall did indeed depend upon mass.

To show that vertical acceleration is independent of the horizontal component of velocity

Procedure 2

A chute is fixed to the top of the plane pointing directly across the slope. A ball bearing released from this acquires a horizontal velocity before it experiences the slope of the plane. If one ball is released from this while another is allowed to roll straight down the plane it can be seen that they both arrive at the bottom together provided the second ball is released at the precise moment the first comes off the chute.

Development

By releasing the ball bearing from higher and higher up the chute, greater and greater horizontal velocity components can be obtained.

If a photogate is used to calculate the horizontal velocity component of a ball bearing released from the chute at the top of the plane, students can try to make predictions about where the ball bearing will roll off the edge at the bottom of the plane (based upon their knowledge of the time taken to reach the bottom).

This practical allows pupils to quickly grasp the ideas involved in orbits, and the dependence of orbiting objects on their horizontal velocity components. This has proven to be an excellent introduction to Kepler's Laws and planetary motion generally.

3 D E N S I T Y

To illustrate the relative densities of liquids

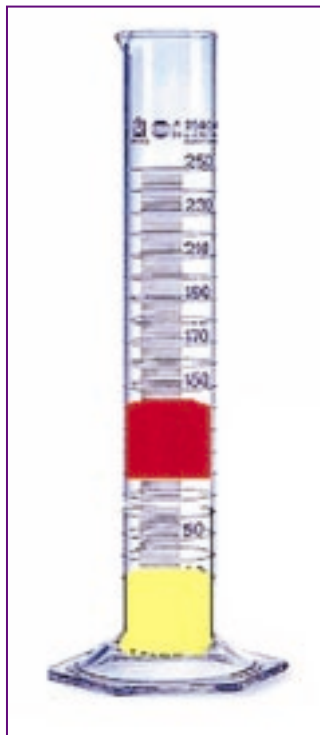

Explanation

Each of the three liquids shown has a different density, with the least dense floating on the top.

Lamp oil 0.8 g/cm^{-3}

Water 1.0 g/cm^{-3}

Sugar syrup 1.3 g/cm^{-3}

To demonstrate the effect of heat on the density of gases

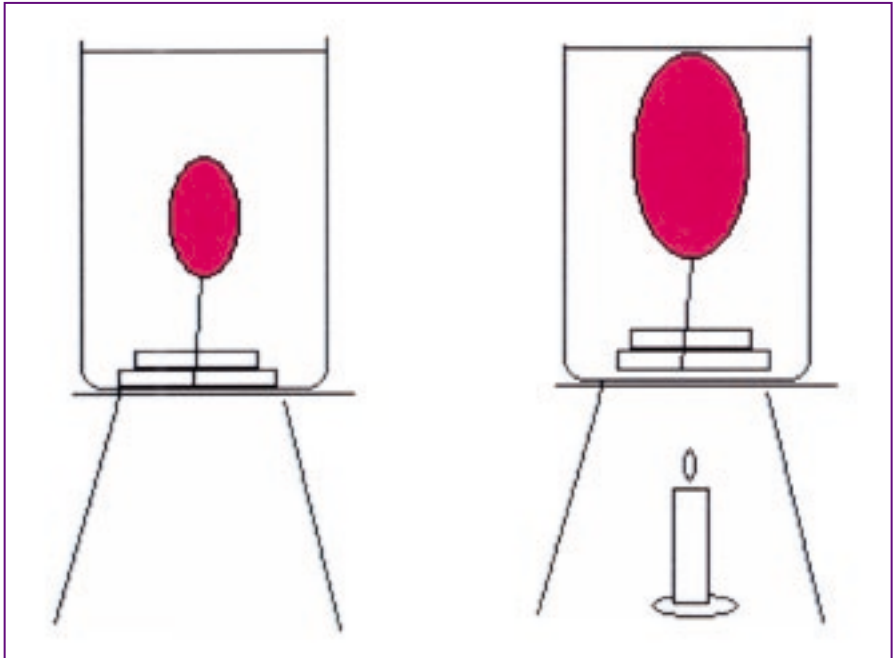

The balloon on the left is submerged in a beaker of ice-cold water. When the water is boiled, the gas is heated and it expands.

To show that carbon dioxide is denser than air

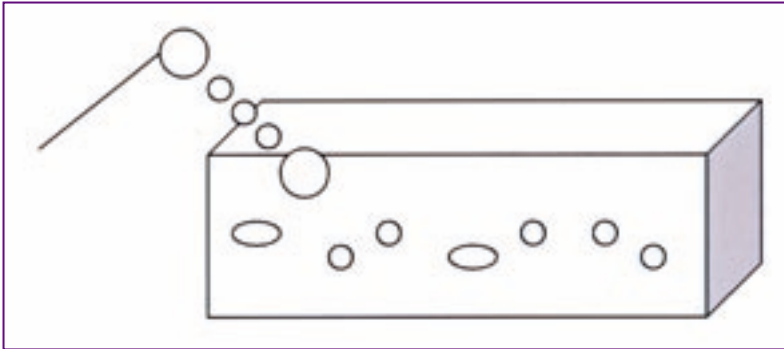

1. Place some dry ice in a clear plastic container.
2. Blow some soap bubbles into the container and see them 'hover' over the layer of cold carbon dioxide which has settled at the bottom of the container.

Eggsperiment 3: sinking eggs

IRELAND:

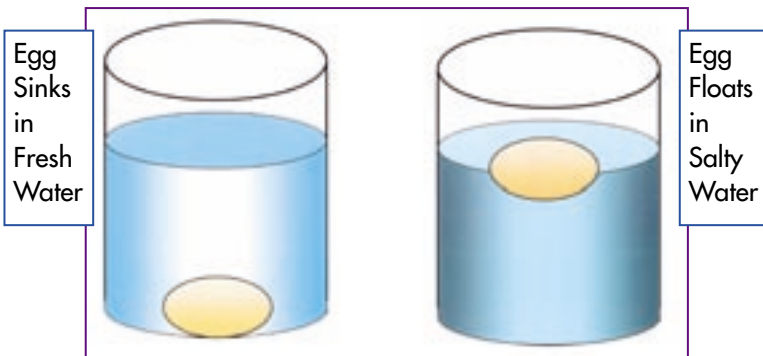

The sinking orange

IRELAND:

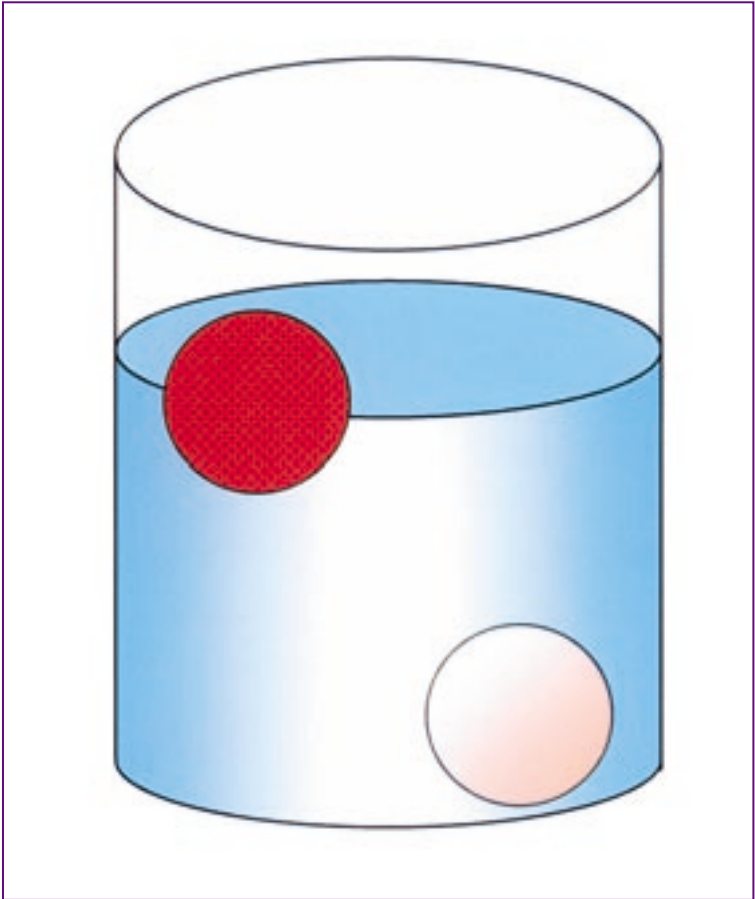

The orange with the skin floats because air is trapped inside.
When the orange is peeled it sinks.

The peel itself will also float until it dries out, then it sinks!

Raisin' the Raisins

IRELAND:

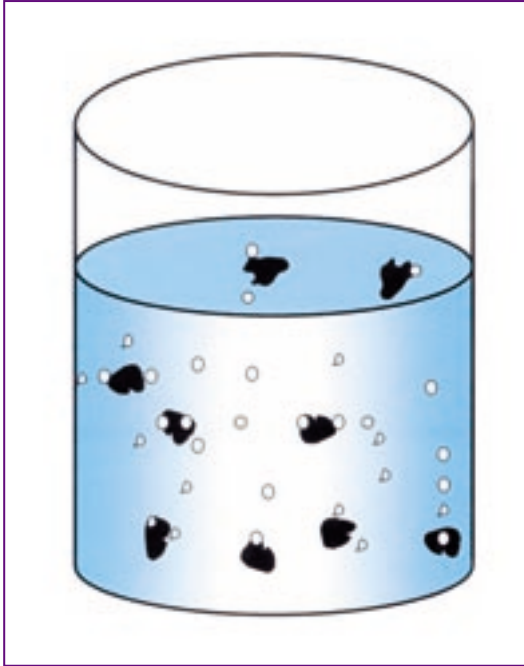

Place some raisins in some fizzy soda.

As they sink bubbles of CO_2 gather on the surface of the raisins, causing them to float.

When the bubbles reach the surface they burst so they sink again.

This continues as long as the soda stays fizzy.

The boat and ball

IRELAND:

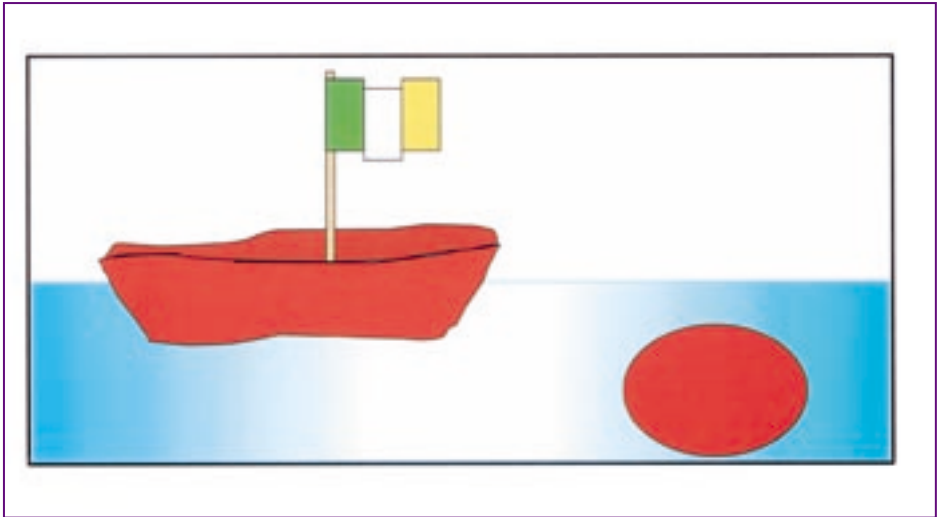

The boat and ball both made from Plasticine, each have equal masses (weights), but because of it's shape the boat floats, while the ball sinks.

Further topics: Density, Buoyancy, Materials etc.

Cartesian diver using dropper and food dye

IRELAND:

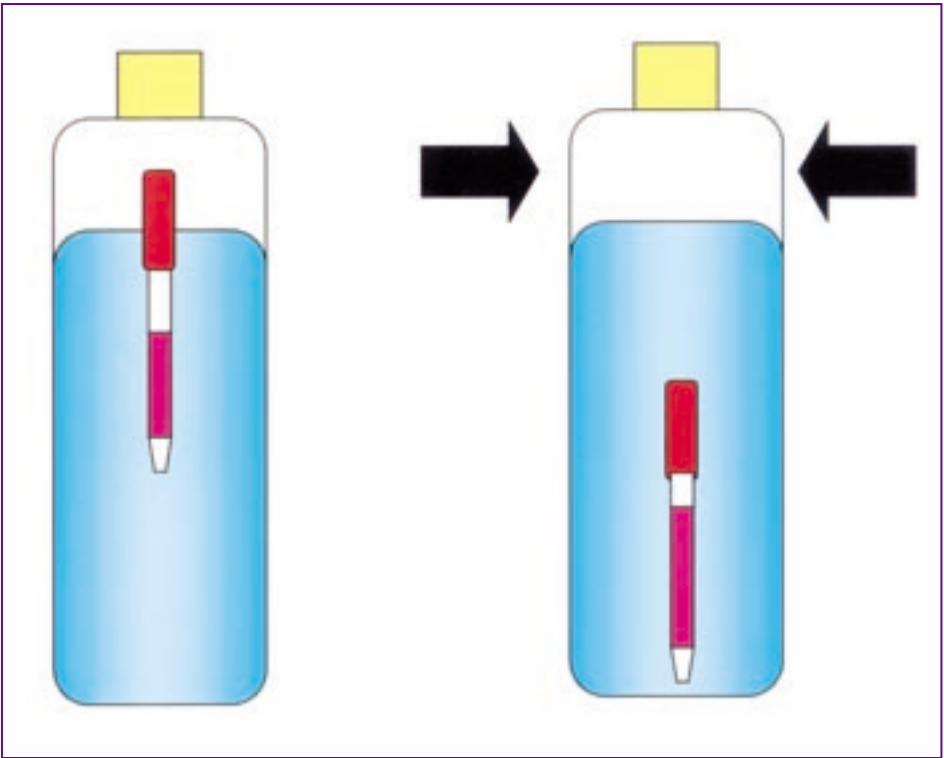

Fill the dropper with as much coloured water as possible.

When you squeeze the shoulders of the bottle you will see the dye expand.

The trapped air above it compresses.

The density of the diver increases and it sinks.

Release the pressure and it floats back to the surface.

Submarine model to demonstrate density and floatation

IRELAND:

The bottle models the ballast tanks on a Submarine. By controlling the amount of air in the tanks the submarine sinks to different depths. Blu-tak can be used to seal the tube in the bottle top. First sink the bottle. The bottle fills with water. Blow into the bottle. Air is pushed out and the bottle rises.

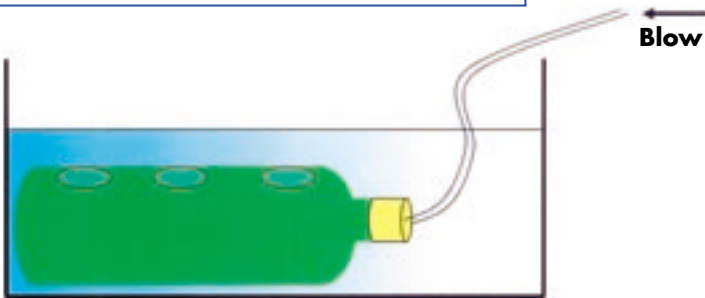

By placing the bottle with the holes facing downwards, the sub will rise quicker and also demonstrate Newton's Third Law.

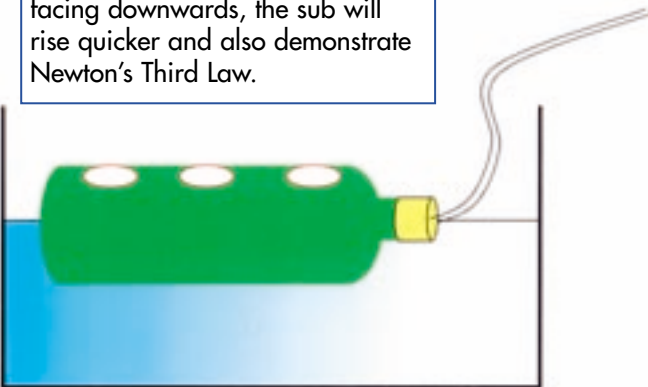

4 H E A T

To show metals are good conductors of heat

BULGARIA: M Cerna and team

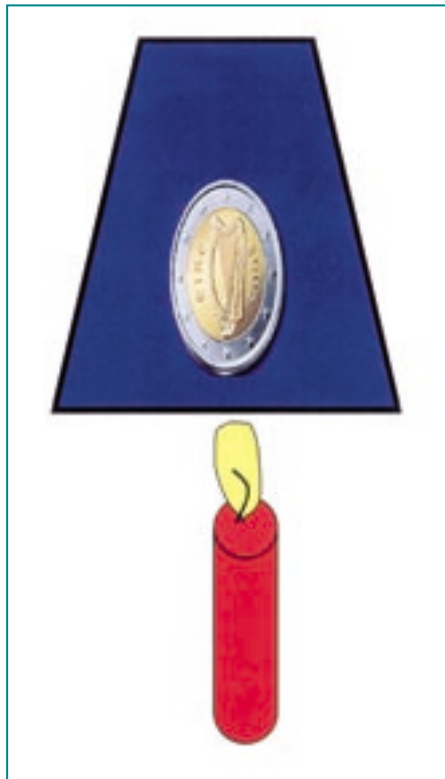

Heat the card directly underneath the coin.
The coin conducts the heat away from the card.

The balloon that doesn't burst

SPAIN: 'Teaching Physics with a Smile' by Rafael Garcia Molina

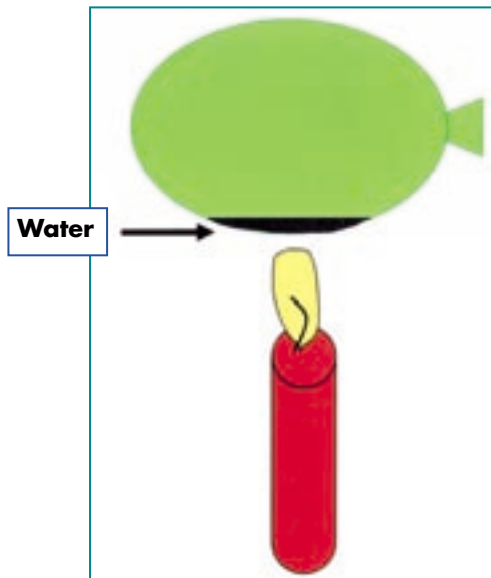

Secretly place some water in a darkly coloured balloon.

Slightly blow up the balloon and tie it.

Holding steadily, heat the balloon below the water.

Amazingly the water's heat capacity is so high the balloon is slow to burst.

Hero's Engine

BULGARIA:

Punch two holes tangentially into an unopened drink can, and empty the can. Bend the ring and tie with thread.

Fill the can with water up to the level of the holes.

Heat the can – When steam starts to leave the holes it will spin in the opposite direction to the steam.

Inserting straws or tubing as shown can increase the effect.

It is based on Hero's steam toy, which he called the 'Ball of the Winds' developed 1500 years before James Watt's concept.

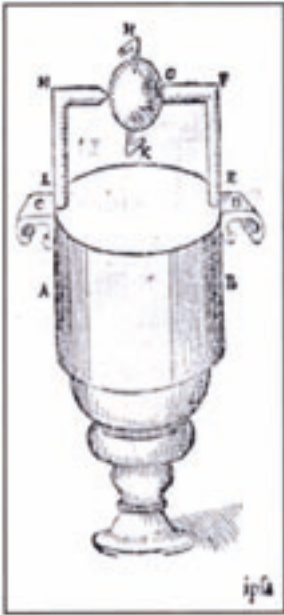

Turbine

When the can is empty, place a weight (or magnet) on the bottom of the can so that it can sink into water. As the water enters the holes, the can will spin in the opposite direction as above.

Further topics: Newton's third Law, Conservation of momentum, Steam Engines Sprinklers, etc.

Jenga Blocks: to show sound travels faster in solids than in liquids/gases

IRELAND:

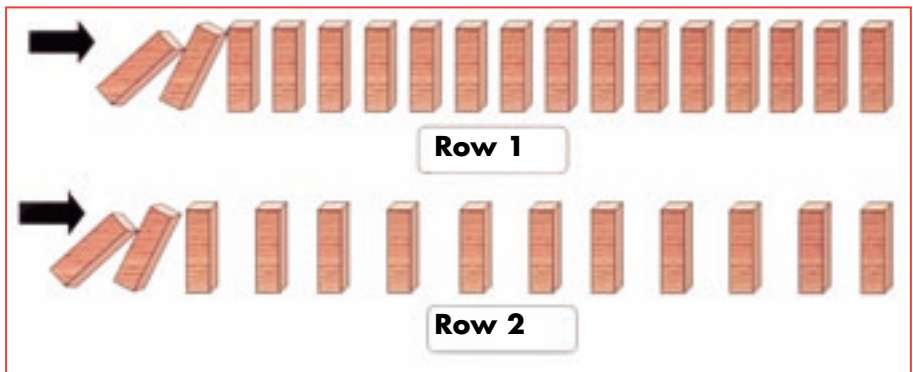

Line up the two rows of blocks as shown.

Row 1 represents a solid.

Row 2 represents a liquid/gas where the particles are spaced further apart.

Knock the two rows together.

The wave will pass faster through Row 1.

To verify the wavelength of electromagnetic waves using a microwave cooker

BELGIUM: 'The Speed of Light: 6 Ways to Measure it' by Bernadette Anbergen



Remove the rotary tray from the microwave.

Spread the grated cheese on the plate (marshmallows or chocolate can also be used).

Read the frequency output from the back of the oven (usually 2450MHz) (f).

Switch on for 20-40 secs.

There will be melted cheese at the antinodes of the standing wave.

Measure the distance between the two nearest antinodes (D).

$$\lambda = 2 \times D$$

$$v = f \times \lambda$$

Typical measurements give a result of 3.2×10^8 m/s.

To show sound is a waveform

GREECE: Elias Kalogirou

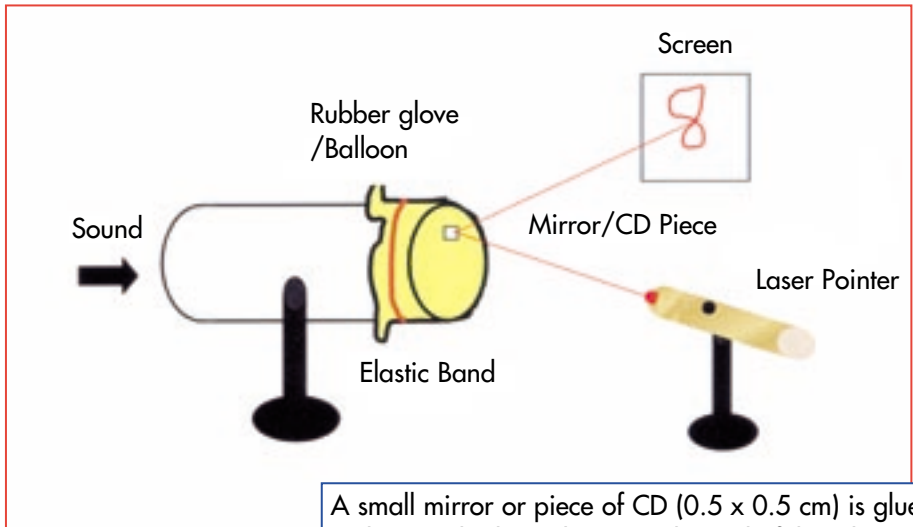

A small mirror or piece of CD (0.5 x 0.5 cm) is glued to the stretched membrane at the end of the tube.

Sing a scale at the open end. Certain frequencies will give complex wave forms.

Louder sounds produce larger vibrations.

SAFETY NOTE: Remind students of the danger of looking into a Laser Beam. Use stands to reduce the movement of the tube and laser.

To make a musical whistle from a drinking straw and show frequency varies with length

UK: Susan Anne McGrath

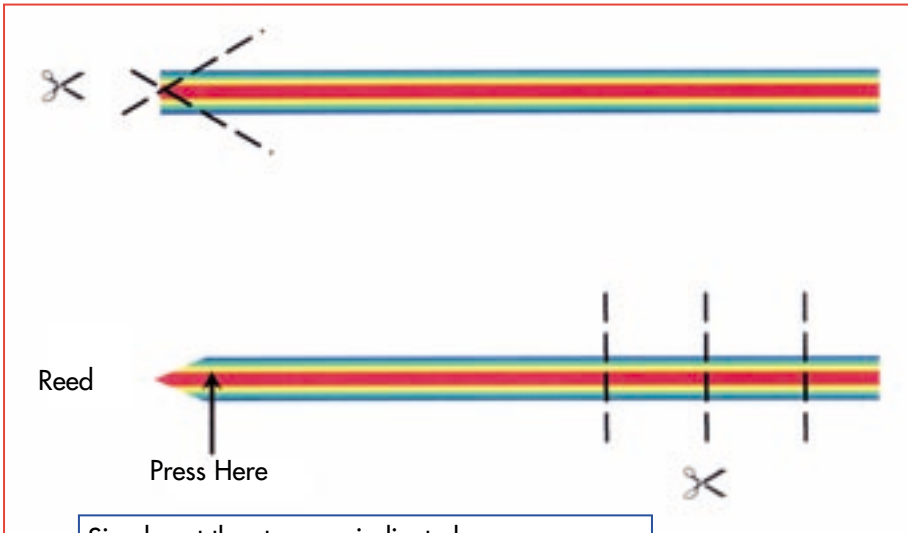

Simply cut the straw as indicated.

It may be necessary to press at the base of the reed to produce the note.

As the straw is cut the note increases in pitch.

It is possible with different lengths to play a tune.

Diffraction using fingers

IRELAND:

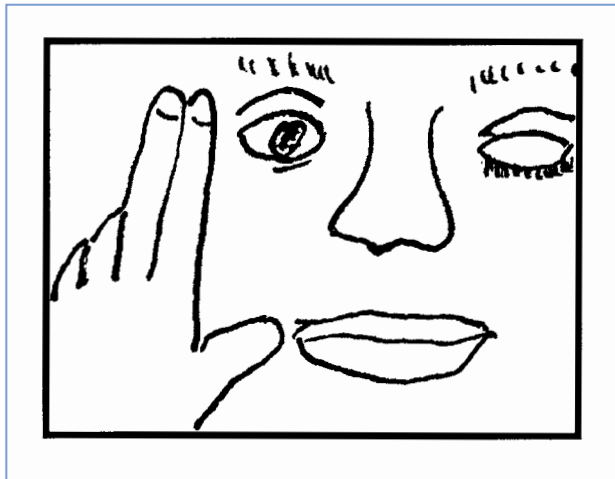

Close one eye.

Place two fingers close together.

Rest the fingertips on your eyebrow.

View a light source through the slit in your fingers.

The very narrow lines are a diffraction pattern.

EASY COLOUR

The next five items are simple modifications of standard experiments. These methods make use of readily available or cheap materials. Good quality *COLOUR FILTERS* have many uses and a handy source is to cut up the large sheets available for a few Euro each from theatre lighting suppliers such as Stage Lighting Centre off Pearse St. Dublin (01-677 3044). Choose colours carefully from the large range available. I find these three in the LEE Filters series work well: Nos : 106, 139 and 363. They are *PRIMARY RED*, *PRIMARY GREEN* and *SPECIAL MEDIUM BLUE*.

EASY COLOUR 1: Exploring white light

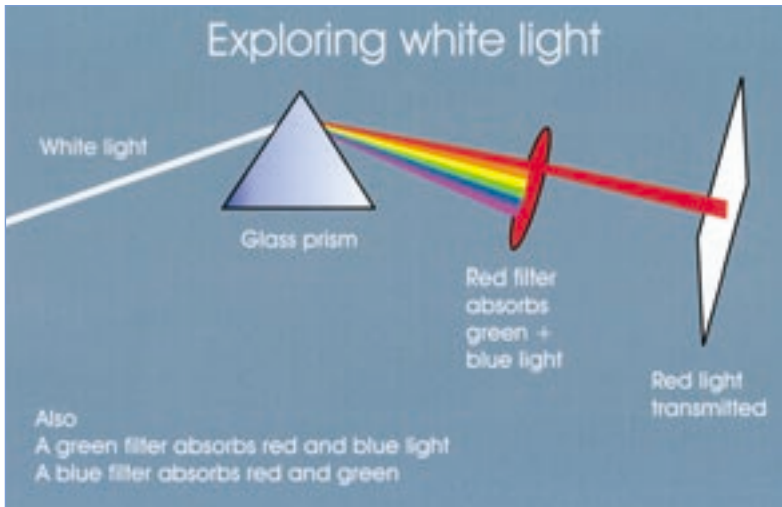

No need for specialised equipment. One easy way to get a narrow beam of parallel white light is to tape two small pieces of opaque card to an empty 35mm slide mount with a gap just less than 1mm between them. Put the slide in the projector, place a triangular glass prism a few cm in front of the projector lens to get a spectrum on a screen or the ceiling. For best results rotate the prism to get the minimum angle of deviation and focus the projector. Now ask your students what a red filter does to white light. Introduce one and see how only the green and blue are absorbed – and so on for the other primary colours.

(To use an overhead projector instead, get two opaque cards about A4 size and place them on the stage with a gap of a few mm between them. Again hold a prism in front of the lens and adjust the gap, and the focussing, to get the clearest spectrum on a screen or ceiling.)

EASY COLOUR 3. Why are sunsets red?

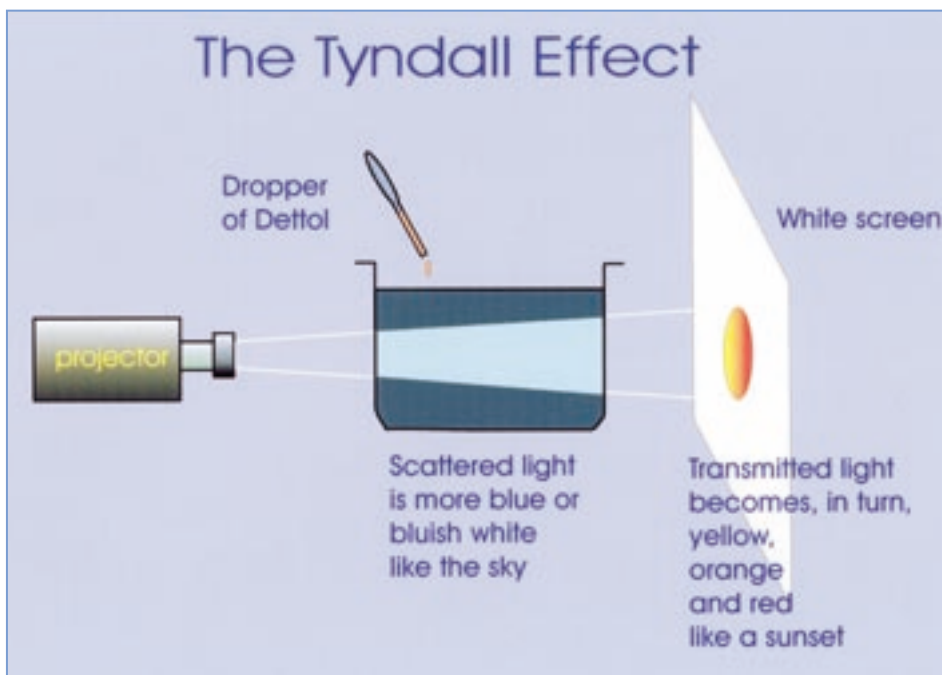

This illustrates the effect of fine particles on long and short light waves, as first explained by John Tyndall from Leighlinbridge, Co. Carlow.

Place a trough of water in front of the lens of a projector. A transparency with a circular hole in the centre is optional and gives a suitable beam of light. Note the colour of the circle of light on a screen. Now use a dropping pipette to add Dettol gradually to the water. Note when the beam scatters enough light to become visible through the side of the trough. Does the *scattered* light have a bluish tinge? Watch the colour of the *transmitted* light on the screen change as more Dettol is added. Discuss wavelengths of red and blue light and the particle size in the colloidal solution. Also, why are rear foglamps red?

EASY COLOUR 4. Red light on tap

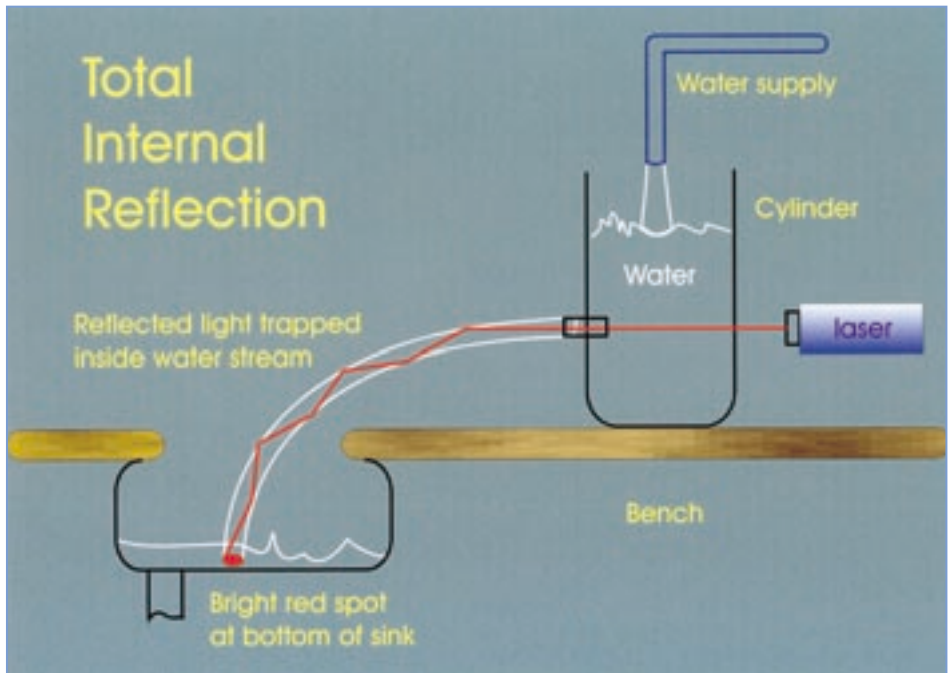

Drink a bottle of mineral water! Cut a small circular hole in the side of the bottle. It helps to fit a centimetre or so of plastic tubing or drinking straw (not too narrow) in the hole. Stand the bottle beside a sink and under a tap so that a steady stream of water pours into the sink. Now shine a laser beam through the bottle and out into the water stream. Note how the water acts as a light guide.

SAFETY NOTE: Take care, as always, that the laser beam does not enter anyone's eye.

EASY COLOUR 5. Tough competition

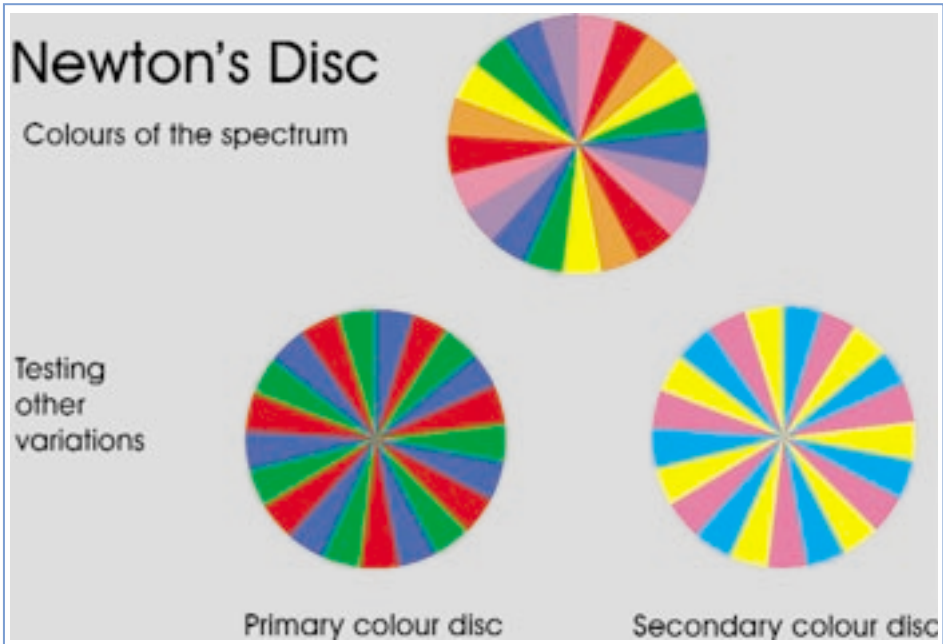

Invite students to make a variety of discs with coloured segments. One way is to provide plenty of brightly coloured paper, some backing card and scissors. If possible let some students, in school or at home, use the drawing tools of a computer package to print out circles of coloured segments. They can guess the best shades and proportions of red, orange, yellow, green, blue, indigo and violet to include. Not easy – choose bright shades for a start.

Now for the competitive bit: Supply a few battery powered fans (available for a few Euro in pound shops or gadget shops) and some pieces of Blue tack.

Invite each group to spin their Newton's disc on a fan, observe all the results and award prizes to the closest approximations to white – the most successful spin doctors!

Estimating the speed of light from some measurements with a laser diode

GREECE:



We can verify an order of magnitude for the speed of light by measuring the wavelength of red light from a laser pointer and the striking voltage of the laser diode.

The author made a diffraction grating of 0.16mm line spacing, by using a drawing package on a computer and printing out the result to make a 35mm slide. We found that a diffraction grating of 300 lines per mm worked very well. Even a pair of homemade Young's slits worked. A 9V battery is connected across a potentiometer. The variable output is measured on a voltmeter and supplied to the laser diode. The minimum voltage at which the laser strikes (giving a very faint light intensity) is recorded. The energy of an electron passing through this potential difference gives the approximate energy of the photons emitted. This is divided by Planck's constant to give the frequency of the red light. Also the spacing between the interference fringes produced by the grating is recorded and this is used to calculate the wavelength of the red light. The product $f \times \lambda$ is our approximation of the speed of light.

A Spectrum with a surprise

POLAND: Jerzy Jarosz and Aneta Szczygieska

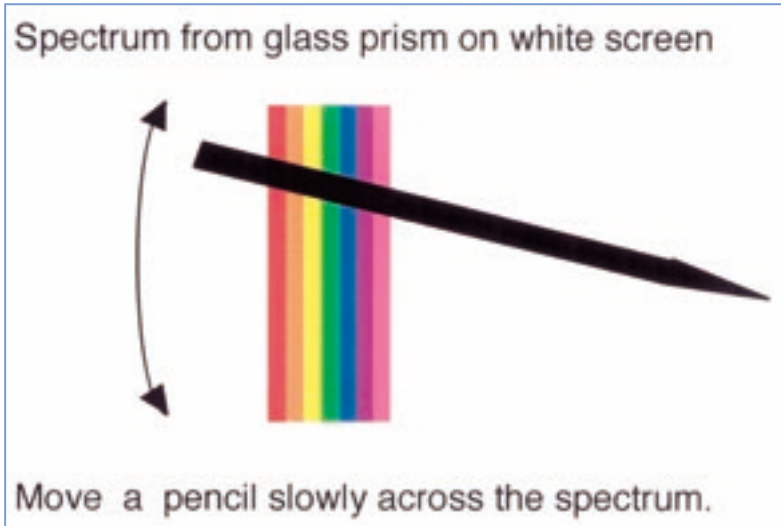

Among various light and vision demonstrations this illusion came as a surprise. Persistence of vision is well known. Movies and Television depend on this time delay in our vision. Surprisingly however the delay seems to be different for different colours. In a darkened room use a triangular prism to show the visible spectrum on a screen in the usual way. Hold a straight stick in front of the the spectrum, so it hides a bit of each colour. Then start moving the stick from side to side and note what you see. The stick appears to bend noticeably – but only while moving across the colours. It seems that the red, green and blue cones in the eye take different times to reset. Molecules of different pigments are being bleached and reformed many times per second in the retina.

Geometric optics with a laser pointer

GREECE:



The photograph, taken at the Greek stand, shows three optics experiments attractively crafted in wood and presented in wooden cases. Each experiment contains a laser pointer built into a movable wooden carriage which can slide or rotate into different positions. The student can use the laser to direct many different incident rays, in turn, onto a curved metal surface representing a concave or convex mirror. In this way she can observe and plot the paths of various reflected rays and discover for herself the ray diagrams seen in textbooks.

Magnetic forces using button magnets in a test tube

CZECH REPUBLIC: Leos Dvorak and team

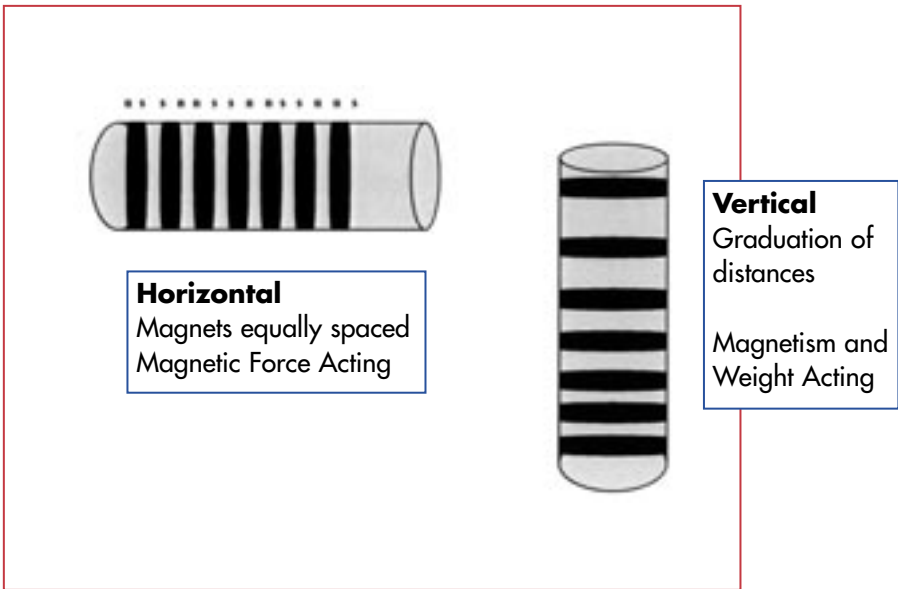

Button Magnets 12.5mm dia (available from Peat's) fit neatly into the test tube.

By placing the magnets in pairs there will be twice the distance in the horizontal case.

The vertical case provides a useful analogy for the graduation in density of the atmosphere.

Further topics: Newton's Third Law, Magnetic Damping, etc.

How to build your own loudspeaker

CZECH REPUBLIC:

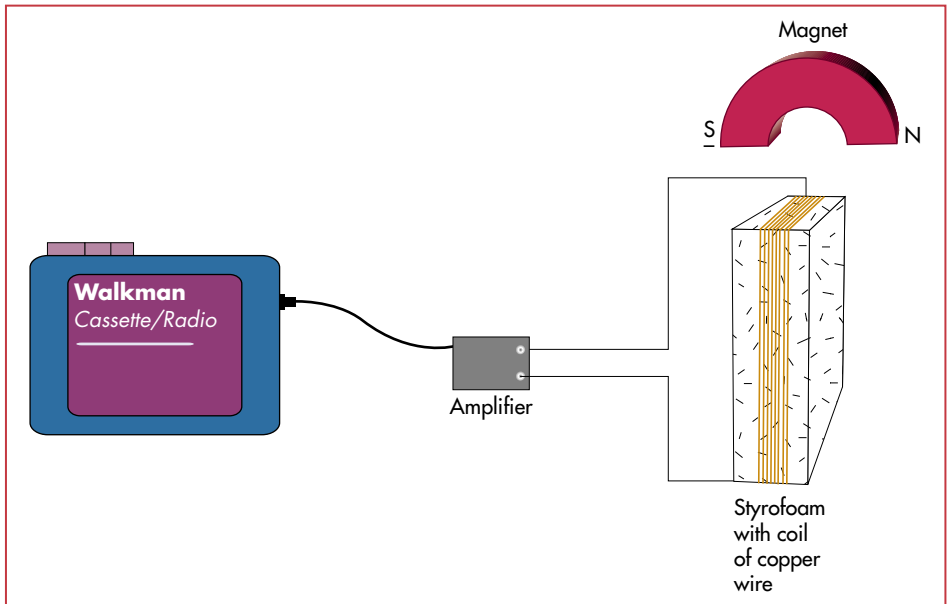

1. Connect a piece of copper wire to a walkman radio/cassette player at the earphone outlet.
2. Connect this wire to an amplifier (e.g. 6V to 15V) and then to a piece of styrofoam.
3. Wind the copper wire around a piece of styrofoam several times to make a coil of wire and tape it in place to the styrofoam.
4. When the radio is playing hold a magnet close to the copper wire and hold this next to your ear to hear the sound being transmitted.

A simple demonstration motor with a twist!

DENMARK: Klaus Seiersen and others

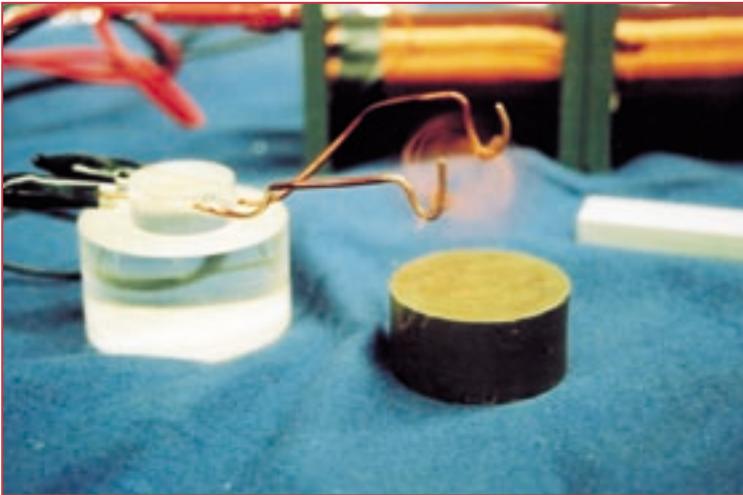

A coil of copper wire rotates in the field of a permanent magnet when connected to a 9V battery. But where is the commutator? The photograph shows the arrangement used by our Danish colleagues. Our version had a coil of 10 turns between two ceramic magnets. The armature is simply a coil of enamelled wire with two straight ends. The ends rest on two thicker pieces of copper wire bent into U shapes and connected to the poles of the battery. The trick is that at one end of the armature you scrape off all the enamel insulation but at the other end you remove the insulation along one side of the wire only. So the coil receives torque for only half of each rotation – and its angular momentum is enough to keep it turning.

Gedanken (thought) experiments with a sheet of A4 paper

Q1. The size of atoms

The length of an A4 sheet is 0.297 metre. If you keep cutting the long side of the sheet in half, how many cuts can you make before you reach atoms?

Q2. The Age of the Universe

Suppose that the thickness of a sheet of paper represents a human lifetime of 70 years.

What would be the height of a stack of paper representing the age of the universe (14 billion years)?

Q3. Filling cylinders

Take two A4 sheets of paper and make two cylinders, the first of height **a** and the second of height **b** where **a** and **b** are the lengths of the long and short sides of the sheets. Fill the first cylinder to the brim with peanuts (or something similar) and transfer the contents to the second cylinder. Why is the second cylinder not filled?

Solutions at end of chapter.

To show that objects with the same surface area have different volumes

Procedure

Take two acetate pages and form two cylinders as shown.
Fill the taller cylinder with a series of marbles.

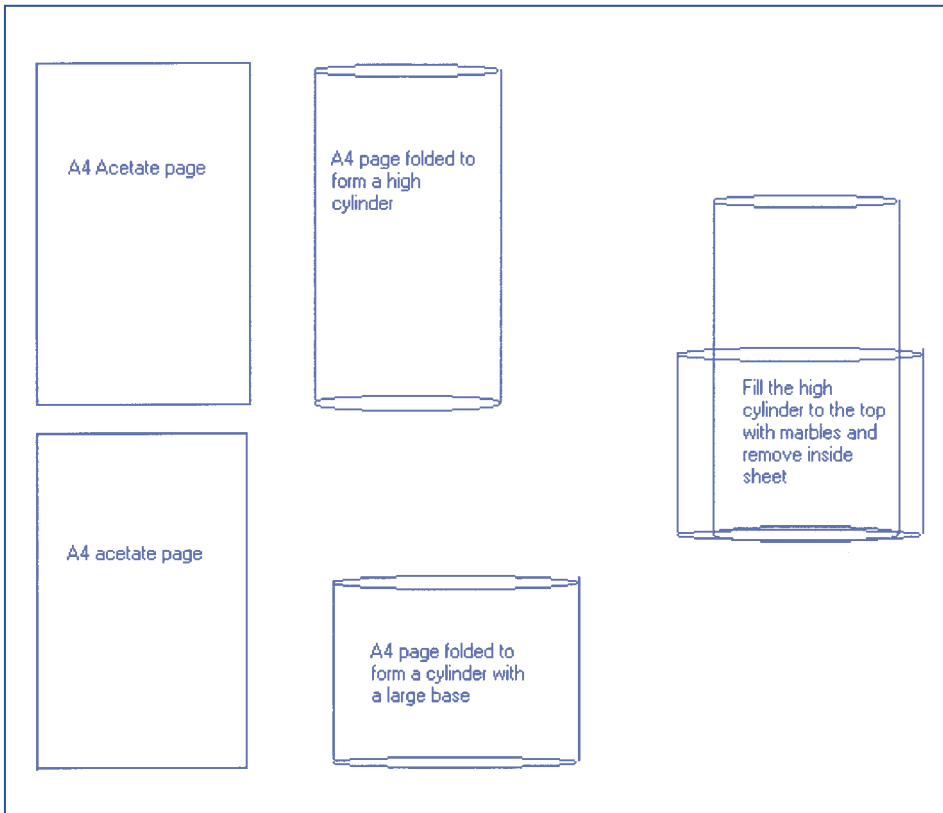

Conclusion

Both sheets have the same area but a different volume.

Can you pick up a cube of ice with a matchstick?

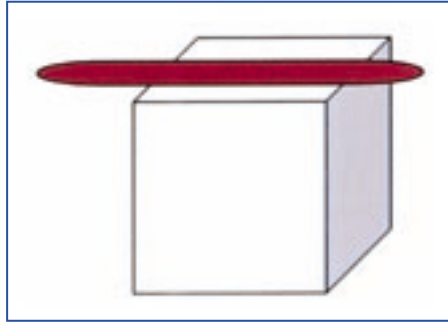

Try sprinkling some salt on the ice cube first and then leave the match stick sitting on it for a few seconds. Then try lifting it up – the match stick is frozen to the ice.

The effect of pressure on the melting point of ice

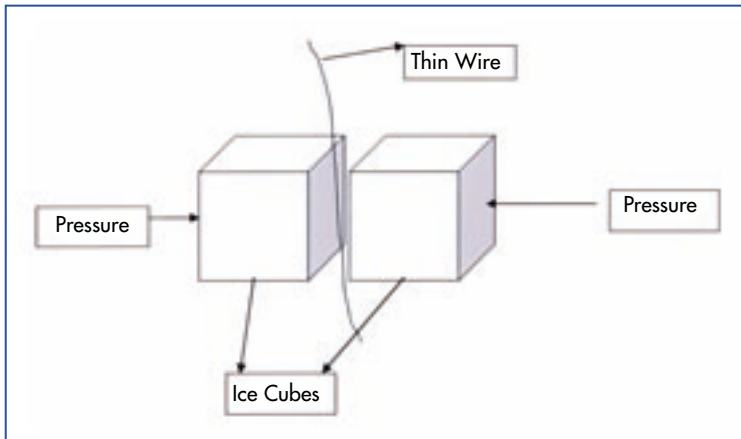

By applying pressure to the two ice cubes (by squeezing together in the palm of the hand) the melting point of the ice is lowered. This allows for a layer of water to form between the two ice cubes. When the pressure is then released the melting point once again being raised allows for the ice to refreeze, thus sticking the wire in place.

To show the amazing elastic properties of a balloon



1. Blow up a balloon.
2. Take a sharp wooden skewer and very slowly push it in through the balloon and out the other side without the balloon bursting. (This takes some practice!)
3. The balloon does gradually deflate over time as the seal is not perfect around the wooden stick but it lasts long enough to be impressive.

Electroless plating

Background

Electroless Plating is the controlled autocatalytic deposition of a metal film by the interaction of a metal salt and a reducing agent. The plating process occurs on the catalytic surface, or on a suitable activated surface.

The reaction can be summarised using

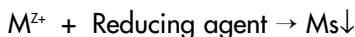

Electroless copper and Nickel deposition have become of great significance in the electronics industry.

The reducing agent traditionally used was Formaldehyde. But recent research has found this to be a carcinogen and alternative reducing agents have been explored.

Most current baths use either Glyoxylic acid or hypophosphite as the reducing agent.

It is possible to make-up these electroless metal baths by purchasing the various chemicals, but they are also commercially available.

Teaching aspect

❖ Discussion on oxidation and reduction reactions

Dipping the coin in acid to remove the metal oxide is an example of an oxidation/reduction reaction. E.g. $NiO + H_2 \rightarrow Ni + H_2O$

❖ The plating reaction

The Ni^{2+} ions come from the Ni salt ($NiSO_4$)

Electrons supplied from the reducing agent (It becomes oxidised and supplies two electrons) instead of the conventional battery.

Resulting in Ni adhesion on the surface of the substrate (coin).

Overall reaction $Ni^{2+} + 2e^- \rightarrow Ni$



Requirements

- ❖ Fume hood required. These baths operate at temperatures of 80-90°C
- ❖ Plating usually complete after 5 minutes.
- ❖ For both the cleaning and activation it is best to dip the metal requiring plating into a solution of dilute acid dip for approximately 20 seconds.
- ❖ Hot plate recommended for heating the solution uniformly.

Materials



Use a glass bottle (a Martini bottle seems to be the best!) and fit a tube through a stopper. Fill the bottle completely and then demonstrate that glass is a flexible material by squeezing on the outer sides of the bottle forcing the liquid to move up the tube.

(By holding your hands around the bottle to warm the liquid this could also be used to show expansion of liquid due to heat.)

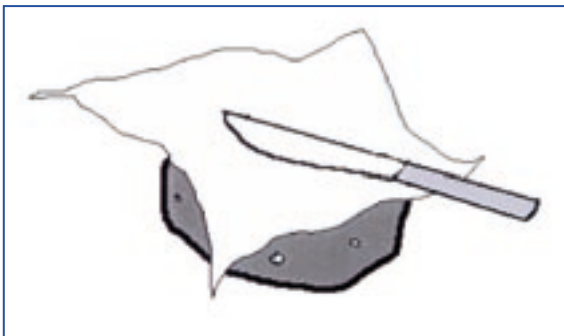

Demonstrate the material properties of kitchen roll by cutting a potato with a knife on a piece of kitchen roll and the kitchen roll remains uncut.

Some exceptionally cool websites

- ❖ www.en.eun.org/vs/physics/physics.html An excellent resource for physics teachers on all matters related to physics. This umbrella website contains links to many general sites including European schoolnet and Physics On Stage.
- ❖ www.fearofphysics.com/ This site illustrates physics in action. It is a visual and non-technical way to see the laws of physics. Particularly appropriate and useful for most students.
- ❖ <http://www.eps.org/> European Physical Society click on the EPS Biographies of Physicists and download some hot free A3 posters.
- ❖ <http://public.web.cern.ch/Public/> A very interesting guide to CERN Don't miss the link for CERN in 2 minutes all you need to know but read quickly!
- ❖ <http://www.lightlink.com/sergey/java/index.html> an exceptional site containing a set of 23 Physics based Java applets by Sergey and Tanya Kiselev highly entertaining.
- ❖ www.physlink.com Provides daily news on a variety of topics including astronomy and includes online educational references.
- ❖ www.exploratorium.edu contains an array of physics links. Particular attention should be shown to the Learning studio link and the Observatory link which provide a guide to Astronomy resources.
- ❖ <http://www.psi-net.org> An excellent site designed specifically for Irish teachers as part of the Physical Sciences Initiative (PSI). Special attention should be paid to the experiments available at <http://www.psi-net.org/physics/s3/s3index.htm>
- ❖ <http://home.a-city.de/walter.fendt/phe/phe.htm> Interesting Java Applets and descriptions are provided on topics such as mechanics, waves, electricity, optics, relativity, radioactivity and spherical astronomy. A particularly useful applet is provided on the electrical motor.
- ❖ <http://physiconstage.net> Contains background information to Physics on Stage2, including Presentations, Performances, The Fair, and Workshops.
- ❖ <http://education.iop.org/> The Institute of Physics Website. Lots of useful resources, downloadable articles from "Physics Education" and information on "Paperclip Physics Competition". <http://www.tcd.ie/IOP/schools.html> details on school affiliation, lectures, video loan scheme, courses and careers in Physics in Ireland.
- ❖ <http://www.physics.org> easily searchable site on all aspects of physics. Results are generated according to the age/knowledge of the user.

Facts of life the Universe and everything...

You are the same age as the universe. The fundamental particles which make up the atoms in your cells were made in the Big Bang.

The Galaxy is a hundred thousand light years across. The most energetic cosmic ray particle yet discovered seems to itself to take just 30 seconds to cross it.

A Clock on the equator runs slow compared with one on the pole.

Antimatter is all around us – but in tiny quantities. Hospitals use it in PET (Positron Emission Tomography) Scanners.

60 Billion neutrinos pass straight through each square centimeter of our bodies each second.

IT Takes the energy output of at least one power station to keep the traffic lights in the British Isles operating.

One Kilogram of butter stores as much energy between its atoms as the same quantity of TNT.

Moving Ions change the electrical potential of heart cell membranes by about 140mV – and the heart beats!

If you keep cutting the long side of an A4 sheet in half, after 31 cuts you start to cut atoms.

If a human lifetime of 70 years is represented by the thickness of a sheet of paper, then a stack of paper representing the age of the universe will reach a height of 20Km.

Some facts reproduced with kind permission from The Institute of Physics.

Answers to thought experiments with a sheet of A4 paper

A1. The size of atoms

Answer: 31

The size of a carbon atom = 10^{-10}m

$2^{10} = 1024$ so 10 cuts reduces the length of the side by 1024

Cut	Length in metres
0	0.297
1	1.485×10^{-1}
11	1.450×10^{-4}
21	1.416×10^{-7}
31	1.383×10^{-10}
32	0.6915×10^{-10}

✂

A2. The Age of the Universe

Answer: 20km

A ream (500 sheets) of $80\text{g}/\text{m}^2$ paper is 5cm thick
so one sheet is 0.1mm thick.

$$\text{No. of sheets} = 14,000,000,000 / 70 = 200,000,000$$

$$\text{Height of stack} = 20,000,000\text{mm} = \mathbf{20 \text{ km}}$$

A3. Filling cylinders

The length of the sides of an A4 sheet are in the ratio $1:\sqrt{2}$
(for information on standard paper sizes see
<http://www.cl.cam.ac.uk/~mgk25/iso-paper.html>)

$$\text{Vol. of a cylinder} = \text{Area of base} \times \text{Height}$$

$$\text{Vol. of 1st cylinder} = \pi (\mathbf{b} / 2 \pi)^2 \times \mathbf{a}$$

$$\text{Vol. of 2nd cylinder} = \pi (\mathbf{a} / 2 \pi)^2 \times \mathbf{b}$$

$$\text{Vol. of 2nd cylinder} / \text{Vol. of 1st cylinder} = \mathbf{a} / \mathbf{b} = \sqrt{2} = 1.414 > 1.00$$

Project suggestion: Students make a large Art Work poster using a collage of photographs, dates and information demonstrating the place of physics discovery in context with literature, art, history, politics etc.

Michaelangelo 1472 1480	Rembrandt 1606 1632	Turner 1775	Picasso 1881	Hockney 1937
Art				
Boticelli paints Birth of Venus Vermeer				

Copernicus: Earth and Planets move around the sun 1543	Newton's Laws Motion & Gravity 1687	Babbage Computer 1834	Rutherford discovers nucleus Atom Split 1909 1938
Physics			
Galileo Theory of Telescope 1593	Franklin discovers Electricity 1750	Special Theory of Relativity 1905	1st Laser built 1938

'Dafne' 1st Opera 1597	Bach & Handel 1685	Mozart 1756	Stravinsky 1882
Music			
1659 Purcell	1770 Beethoven	1840 Tchaikovsky	1924 Gershwin

Elizabeth 1st defeats Spanish Armada 1588	Ulster Plantations 1609	French Revolution 1789 1848	World War I 1914	Atom bomb 1945
Politics				
George Washington 1st president USA Karl Marx Communist Manifesto				

Columbus reaches America 1492	Captain Cook sails into Botany Bay 1770	Tutankhamun discovered 1922
Exploration		
East India Company formed to trade with India 1600	Peary reaches North Pole 1909	Amundsen reaches South Pole 1911